

EPL1720 Series

• 750W Max.

Enclosed AC/DC Switching Power Supply



Features

- Applicable to Photographic lamp
- 100-240VAC Universal Input
- Constant voltage
- Protections:
Short circuit / Over voltage / Over current
Over Temperature (optional)
- Energy Efficiency $\geq 94\%$ 230VAC Full Load
- MTBF > 50,000 hours

MODEL No.	MAX. OUTPUT POWER (W)	OUTPUT VOLTAGE (Vo)	MIN.	MAX.	LOAD REGULATION	LINE REGULATION	RIPPLE & NOISE
			LOAD(Io)	LOAD(Io)			
EPL1720	750W	48V	0A	15A	$\pm 5\%$	$\pm 1\%$	480mV

NOTE:

- 1 : Ripple & Noise is measured by using 20MHz bandwidth limited oscilloscope and terminated each output with a 0.1uF ceramic capacitor & parallel with 47uF aluminum capacitor at full load and nominal line.
- 2 : Line regulation is defined by changing $\pm 10\%$ of input voltage from nominal line at rated load.
- 3 : Max. Power (W) $\geq V_o \times I_o$

Electrical Specification

INPUT

- Input Range: 100 to 240VAC
- Frequency: 50 to 60Hz
- Input Current: $\leq 8A$
- Inrush Current: 50A/110VAC 100A/220VAC
- Hold Up Time: $\geq 8.3ms$
- Turn On Time: $\leq 3s$

OUTPUT

- Short Circuit Protection: Auto Recovery
- Over Voltage Protection: Latch off or Auto Recovery
- Short Circuit Protection: Auto Recovery

ENVIRONMENT

- Operating Temperature: 0 to 50°C
- Storage Temperature: -20 to 85°C
- Operating Humidity: 10% to 90 %
- Storage Humidity: 5% to 95 %

SAFETY

- Complied with TUV EN 61347, CB IEC 61347, CE, FCC

Mechanical Specification

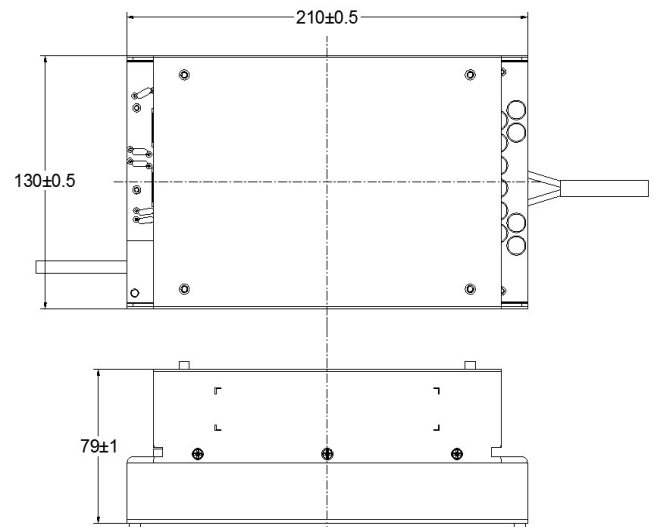

- Mechanical Size: 210L x 130W x 79H (mm)
- AC Input cable: UL3135 16AWG
- DC output cable: UL3135 12AWG
- Weight: 2200g

Above safety certificates are for reference only. Please contact our sales department for more details.